

SPECIFICATIONS

1. General Information

- . Housing: Thermoplastic, UL 94 V-0
- . Terminal: Phosphor Bronze
- . Plating: Gold Plating On Contact Area
Tin Plating On Solder Tails

2. Electrical Specification

- . Contact Resistance: 50 Milliohms Max.
- . Insulation Resistance: 1000 Megohms Min. At DC 500V
- . Dielectric Withstanding Voltage: 500V AC R.M.S. For 1 Minute
- . Current Rating: 0.5A Max.

3. Mechanical Specification

- . Durability: 5000 Cycles

4. Environmental Specification

- . Operation Temperature: $-25^{\circ}\text{C} \sim +85^{\circ}\text{C}$
- . Resistance To Soldering Heat:
Manual Soldering: 360°C , 3 Sec. Max.
Vapor Phase: 215°C , 30 Sec. Max.
IR Re-flow: 260°C , 15 Sec. Max.

- . RoHS Compliant

Part No:

SC V- W 06 A 25- 020 A R-H

- RoHS Compliant
- Reel Packing
- With peg & switch
- Selective Gold Flash
- Base Height, 2.5mm
- Row Pitch, 25.22mm
- No. Of Pins, 6pins
- SMT, Right Angle Type(90°)
- Hinged Cover
- Smart Card/Sim Card

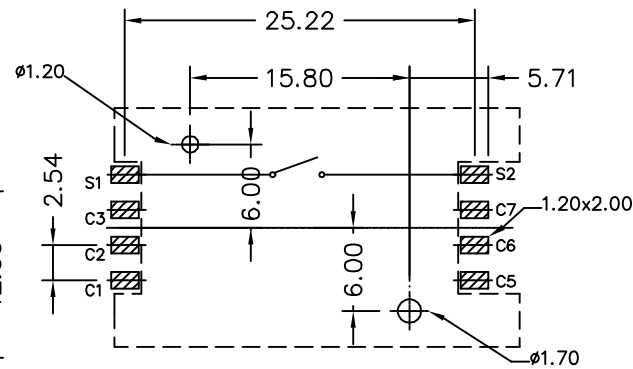
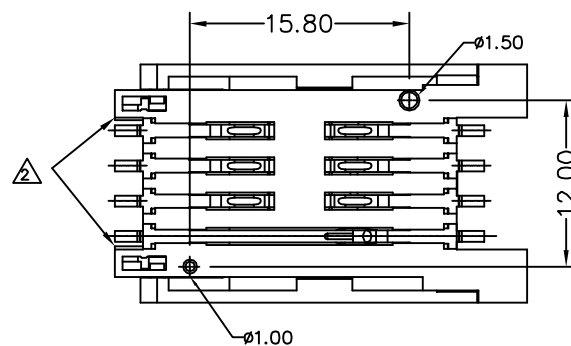
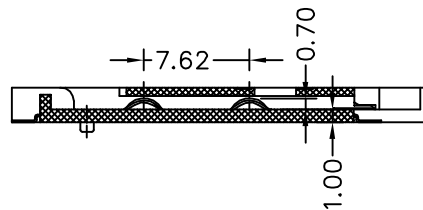
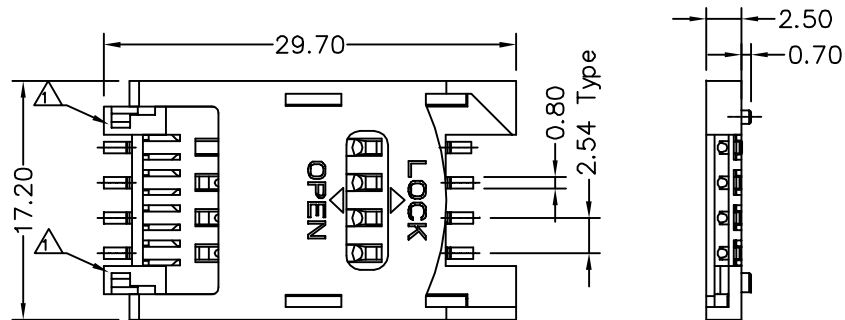
(.XX \pm 0.05)

REFERENCE PCB LAYOUT

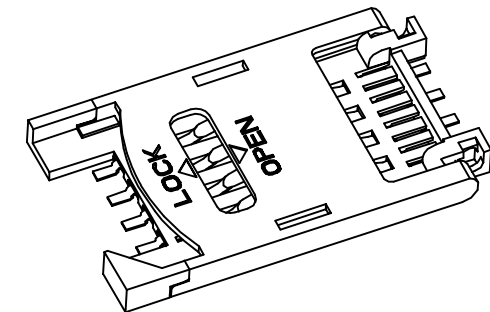
AUK

A MEMBER OF AUK GROUP

太聯事業股份有限公司
AUK CONTRACTORS CO., LTD.
CATEGORY
Smart Card/Sim Card

APPROVED BY

QXQ

PART No.
SCV-W06A25-020AR-H

CHECKED BY

CATHY

DRAWING No.
SCV-W06A25-020AR-H

DRAWING BY

QXQ

SCALE

NONE

REV.

A3

UNLESS OTHERWISE
SPECIFIED
TOLERANCES ARE.X \pm 0.38.XX \pm 0.25ANG. $\pm 1^{\circ}$

UNIT

mm

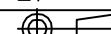

NO.	REV.	REVISIONS	CHK	DATE
△	A3	MARKED △ IS MODIFIED	QXQ	08/31/2010
△	A2	ADD CHAMFER	XSH	01/08/2008
△	A1	MODIFIED AXES	XSH	09/26/2007
△	A0	NEW RELEASE	XSH	01/04/2006

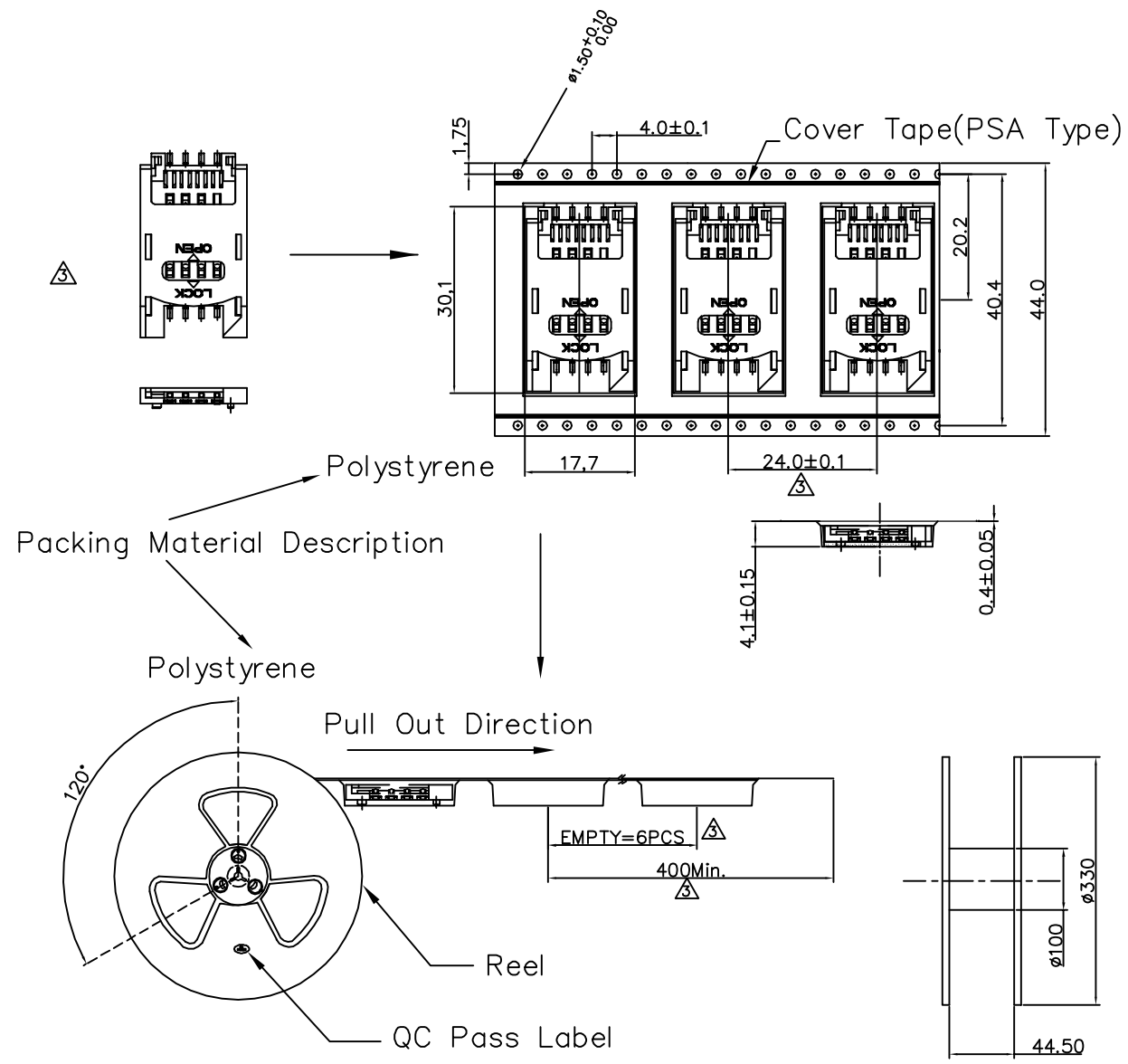

SPECIFICATIONS:
 Reel Size : 330*44.5 mm
 QTY : 650Pcs/Reel
 RoHS Compliant

CATEGORY Smart Card/Sim Card		APPROVED BY QXQ		UNLESS OTHERWISE SPECIFIED TOLERANCES ARE .X ±0.20 .XX ±0.10 ANG. ±1° UNIT mm
PART No. SCV-W06A25-020AR-H		CHECKED BY CATHY		
DRAWING No. SCV-W06A25-020AR-H		DRAWING BY QXQ		
SCALE	NONE	REV.	A3	

△ A3	MARKED △ IS MODIFIED	QXQ	08/31/2010
△ A2	ADD CHAMFER	XSH	01/08/2008
△ A1	MODIFIED AXES	XSH	09/26/2007
△ A0	NEW RELEASE	XSH	01/04/2006
NO. REV.	REVISIONS	CHK	DATE